

## QTi 3X14/24 DIM

QUICKTRONIC INTELLIGENT DIM T5 | ECG dimmable 1...10 V for FL 16 mm



### Product family features

- Control via 1...10 V interface
- Supply voltage: 220...240 V
- Line frequency: 0 Hz | 50 Hz | 60 Hz
- Line voltage: 198...264 V
- Dimming range: 1...100 % luminous flux
- Lamp start: within 0.6 s
- Lifetime: > 100,000 h (for  $T = 65\text{ }^{\circ}\text{C}$  at  $T_c$ )
- Automatic shutdown of defective lamps and at end of life (EoL T.2)
- Energy Efficiency Index EEI: A1 BAT
- Overtemperature protection: Thermal management at high  $t_c$  temperatures
- Safety: to EN 61347-2-3
- Lamp operation: to EN 60929
- RI suppression: to EN 55015:2006+A1:2007+A2:2009/CISPR 15
- Line harmonics according to EN 61000-3-2
- Immunity according to EN 61547

### Product family benefits

- Same luminous flux with direct and alternating current
- Perfect lamp start for applications with motion sensors
- Dimming of amalgam lamps without flickering or reduced lifespan
- Very high efficiency thanks to cut-off technology
- Automatic restart after lamp replacement
- ECGs comply with MINERGIE standard due to very low standby consumption
- Configurable emergency power characteristics

### Areas of application

- Suitable for emergency installations
- Industry
- Open-plan offices, corridors and storage rooms
- Public buildings
- Suitable for luminaires of protection class I

# Product datasheet

## Technical data

### Electrical data

Input voltage AC	198...264 V
Nominal voltage	220...240 V
Mains frequency	50...60 Hz
Input voltage DC	154...276 V
Maximum output power	3 x 24 W
Efficiency in full-load	92 % <sup>1)</sup>
Operating frequency	40...100 kHz
Max. ECG no. on circuit breaker 10 A (B)	12 <sup>2)</sup>
Max. ECG no. on circuit breaker 16 A (B)	19 <sup>2)</sup>
Inrush current	35 A

<sup>1)</sup> at 230 V, 50 Hz

<sup>2)</sup> Type B

### Light technical data

Starting time	0.6 s <sup>1)</sup>
---------------	---------------------

<sup>1)</sup> Optimized preheat start

### Dimensions & weight

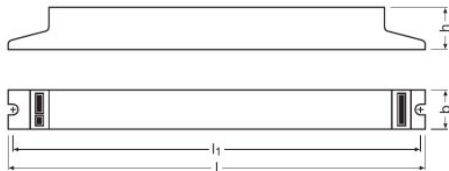

Length	360.0 mm
Width	40.0 mm
Height	21.0 mm
Mounting hole spacing, length	350.0 mm
Product weight	394.00 g
Cable cross-section, output side	0.5...1.5 / 0.5...1.0 mm <sup>2</sup> <sup>1)</sup>
Cable cross-section, input side	0.5...1.5 / 0.5...1.0 mm <sup>2</sup> <sup>1)</sup>

<sup>1)</sup> Solid leads / Flexible

## Temperatures & operating conditions

Ambient temperature range	+10...+50 °C
Permitted rel. humidity during operation	5...85 % <sup>1)</sup>

<sup>1)</sup> Maximum 56 days/year at 85 %

## Lifespan

ECG lifetime	100000 h <sup>1)</sup>
--------------	------------------------

<sup>1)</sup> At  $T_{case} = 65^{\circ}C$  at  $T_c$  point / 10% failure rate

## Additional product data

Suitable for lamp power (3 lamps)	14...24 W
-----------------------------------	-----------

## Capabilities

Dimming interface	1...10 V
Dimming range	1...100 % <sup>1)</sup>
Dimmable	Yes
Overheating protection	Power reduction and switch off at $T > 75^{\circ}C$ at the tc point
Suitable for fixtures with prot. class	I
End of lamp life safety shutdown	EOL T.2
Max. cable length to lamp/LED module	1.0 m
Intended for no-load operation	No

<sup>1)</sup> Luminous flux

## Certificates & standards

Approval marks – approval	VDE / VDE-EMC / EL / EAC / RCM / CCC
Standards	Acc. to EN 61347-2-3/Acc. to EN 60929/Acc. to EN 55015:2006 + A1:2007/Acc. to EN 61000-3-2/Acc. to EN 61547
EEL – Energy Label	A1 BAT
Protection class	I
Type of protection	IP20

## Logistical data





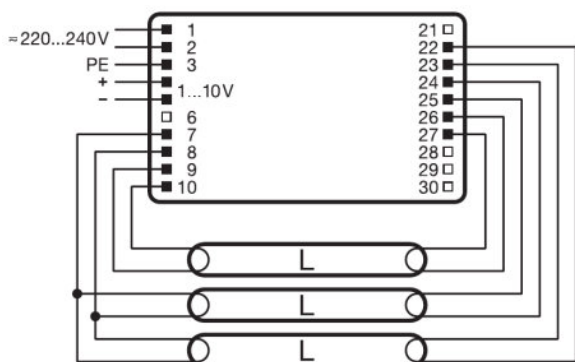



Commodity code	850410809000
----------------	--------------

### Wiring Diagram











319621\_QTi 3x... DIM

### Download Data

File	
	Addon Technical Information 502689_Frequent switching Quicktronic
	Addon Technical Information 502785_ECG lifetime - QUICKTRONIC (DALI) DIM
	Certificates 334953_EMC-Marks approval
	Certificates 335097_INOTEC
	Certificates QTI DALI VDE 40021252 210920
	Certificates 335135_Manufacturer's declaration &#150; Burning-in of fluorescent lamps
	Certificates 335153_Manufacturer's declaration &#150; Low stand-by
	Certificates 335154_Manufacturer's declaration &#150; EN 55015:2006+A1:2007 (300 MHz)
	Certificates 335169_Manufacturer's declaration &#150; LampECG combinations: Frequent switching

## Product datasheet

---

	Certificates 592319_EAC certificate for Quicktronics QT
	Certificates 504208_VDE-EMC-CERTIFICATE QTl DALI DIM
	Declarations of conformity Quicktronic DIM CE 3364258 180121
	Operating instructions 592412_EAC QTl T5 DIM
	CAD data 3-dim 321729_QTi 3x1424220-240 DIM
	CAD data 3-dim 321730_QTi 3x1424220-240 DIM
	CAD data 3-dim 321731_QTi 3x1424220-240 DIM
	CAD data PDF 321728_QTi 3x1424220-240 DIM

---

### Ecodesign regulation information:

Separate control gear and light sources must be disposed of at certified disposal companies in accordance with Directive 2012/19/EU (WEEE) in the EU and with Waste Electrical and Electronic Equipment (WEEE) Regulations 2013 in the UK. For this purpose, collection points for recycling centres and take-back systems (CRSO) are available from retailers or private disposal companies, which accept separate control gear and light sources free of charge. In this way, raw materials are conserved and materials are recycled.

### Logistical Data

Product code	Product description	Packaging unit (Pieces/Unit)	Dimensions (length x width x height)	Volume	Gross weight
4008321069719	QTl 3X14/24 DIM	Shipping carton box 20	384 mm x 90 mm x 237 mm	8.19 dm <sup>3</sup>	8672.00 g

---

The mentioned product code describes the smallest quantity unit which can be ordered. One shipping unit can contain one or more single products. When placing an order, for the quantity please enter single or multiples of a shipping unit.

### Disclaimer

Subject to change without notice. Errors and omission excepted. Always make sure to use the most recent release.

## QTi 3X14/24 DIM

QUICKTRONIC INTELLIGENT DIM T5 | ECG dimmable 1...10 V for FL 16 mm

Product name	Lamp group	Nominal current	Nominal wattage + Power loss	Power factor $\lambda$ [PIM]	Luminous flux at 35 °C	Number of lighting outlets
QTi 3X14/24 DIM	DULUX F 24 W	0.32 A	74.00 W	0.99	1700 lm	3
	DULUX L 24 W	0.32 A	73.00 W	0.99	1800 lm	3
	FC 22 W	0.32 A	73.00 W	0.99	1750 lm	3
	HE 14 W	0.20 A	45.30 W	0.97	1200 lm	3
	HO 24 W	0.32 A	74.00 W	0.99	1750 lm	3